

A-A (2 : 1)

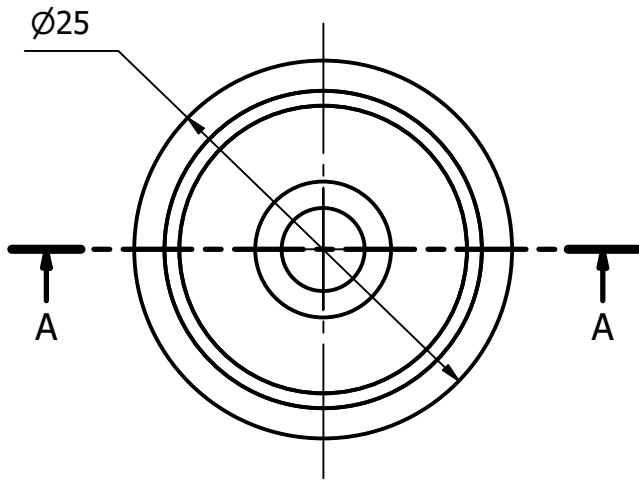
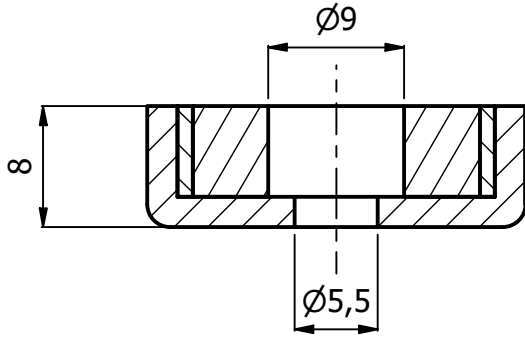

Rev.	Descrizione modifiche	Data	Firma

Disegnato M.D.	Data 28/08/2023	Materiale Neodimio	Trattamento Nichelato	Tolleranza +/- 0.15	Unità mm
-------------------	--------------------	-----------------------	--------------------------	------------------------	-------------

ITALFIT magneti

Via Comelli, 39
33034 Fagagna (Ud)
Tel 0432/801675 Fax 0432/810197
P.IVA e C.F. 02610340305

Descrizione
Sistema magnetico in neodimio con foro cilindrico (N+S)

Codice
SM31.35NI00.2508

Scala
2 : 1

Formato
A4